

Article number: 60415127010

Description: Timing Belt Pulley 27 T5 10/2

Measures

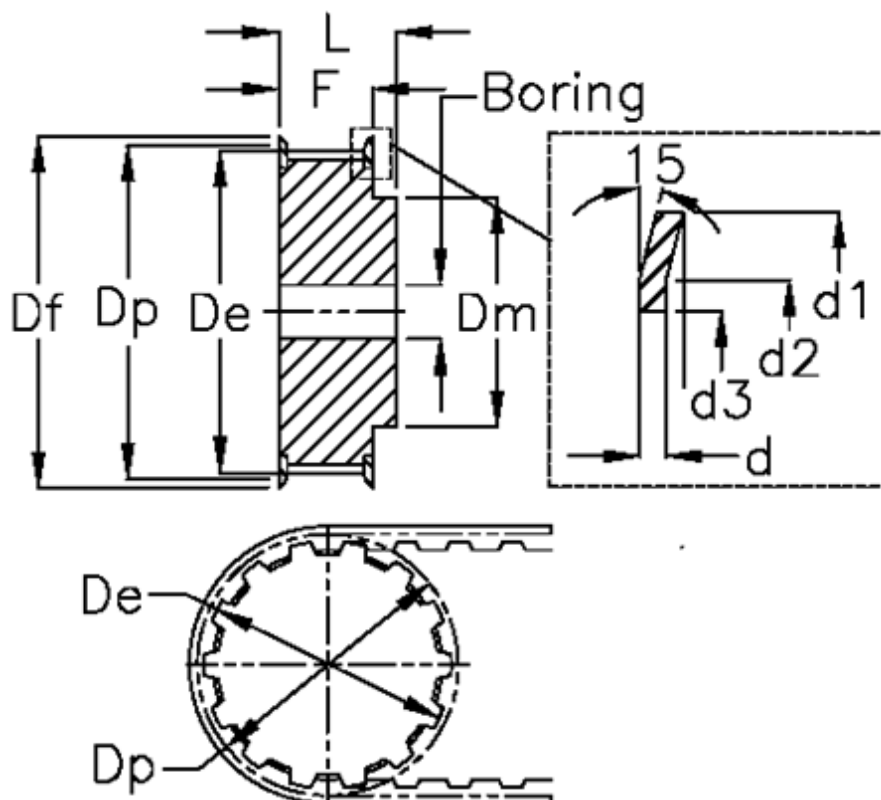

Belt width = - 16 mm	D_p	= 16.05
d = 1	F	= 21
d_1 = 20	Flange type	= F06
d_2 = 16.5	L	= 27
d_3 = 12.2	Pre-drilled	= 4
D_e = 15.05	Tooth number	= 10
D_f = 20	Type	= T5
D_m = 8	Weight	= 0.016